

17 - 0104



MODULE DE TRANSMISSION GPRS MINI HF

GPRS HF MINI TRANSMISSION MODULE

GPRS-FUNKÜBERTRAGUNGSEINHEIT MINI

GPRS HF MINI-VERZENDMODULE

MODULO DE TRANSMISION GPRS RF MINI



NO
110 VOLTS
220 VOLTS

YES
12 VOLTS
24 VOLTS



-10°C / 45°C

<70%



INTRATONE

INTRATONE
ZI de Maunit 370 rue de Maunit
85290 MORTAGNE SUR SEVRE
FRANCE

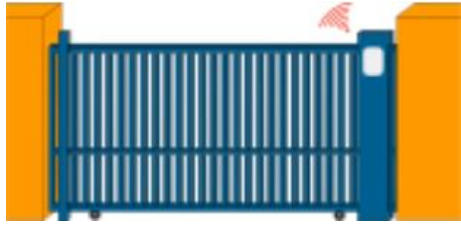

X 2 MAX



X 10 000 MAX

www.intratone.info



X 2 MAX

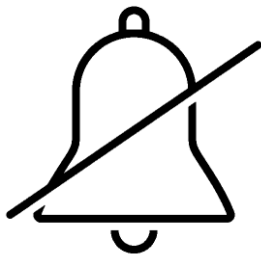

**Pas de gestion d'alerte
No alert management
Keine Alarmverwaltung
Geen alert management
Sin gestión de alertas**

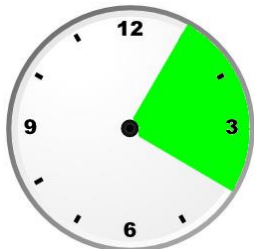

**Plages horaires et accès libre
Time zones and free access
Zeitzone und freier Zugang
Tijdzones en gratis toegang
Zonas horarias y acceso libre**

www.intratone.info

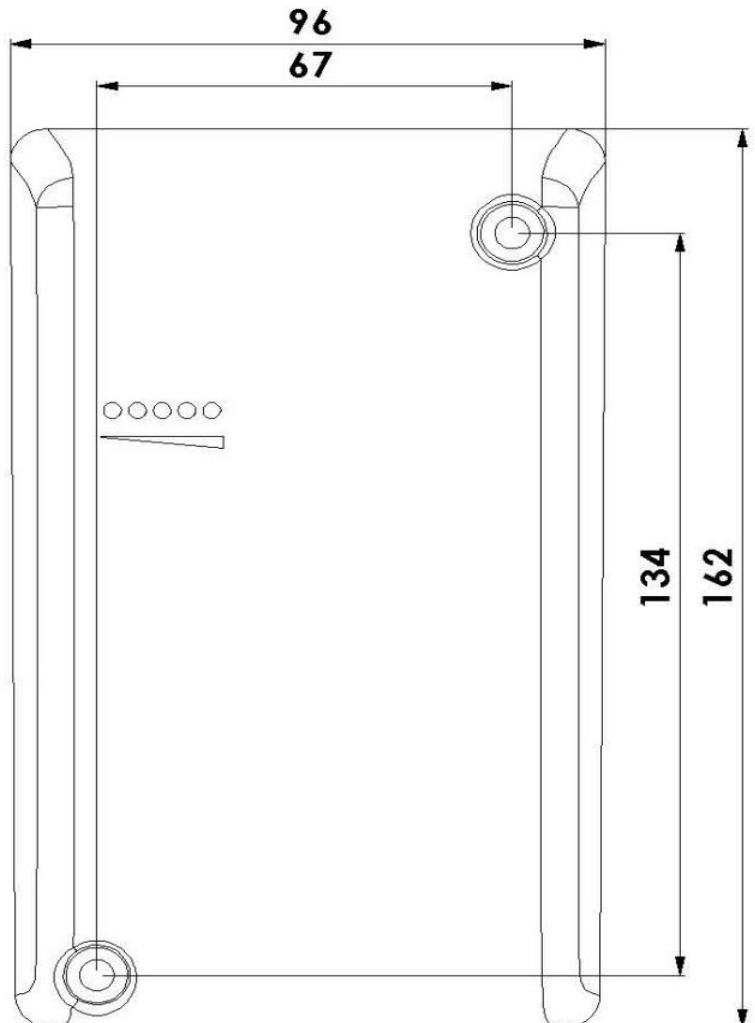
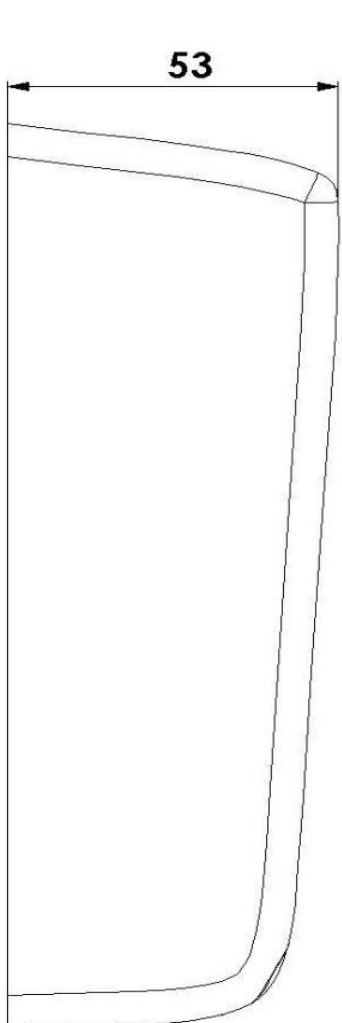
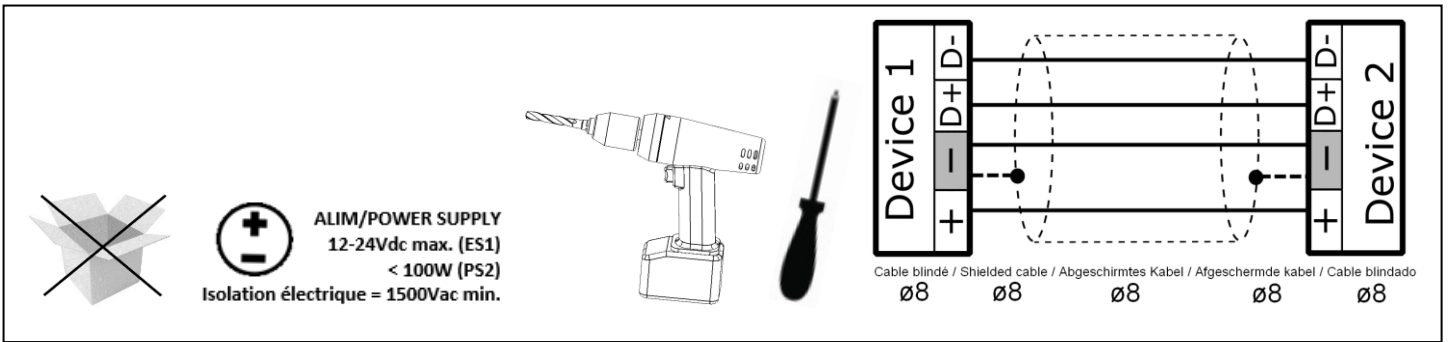
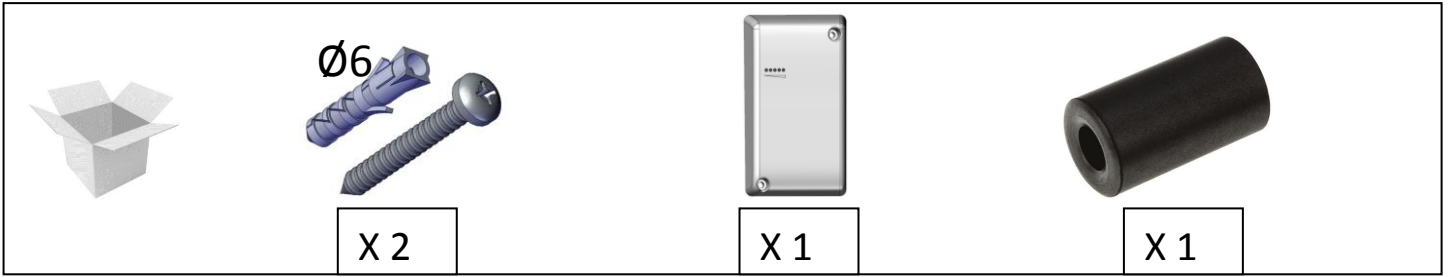

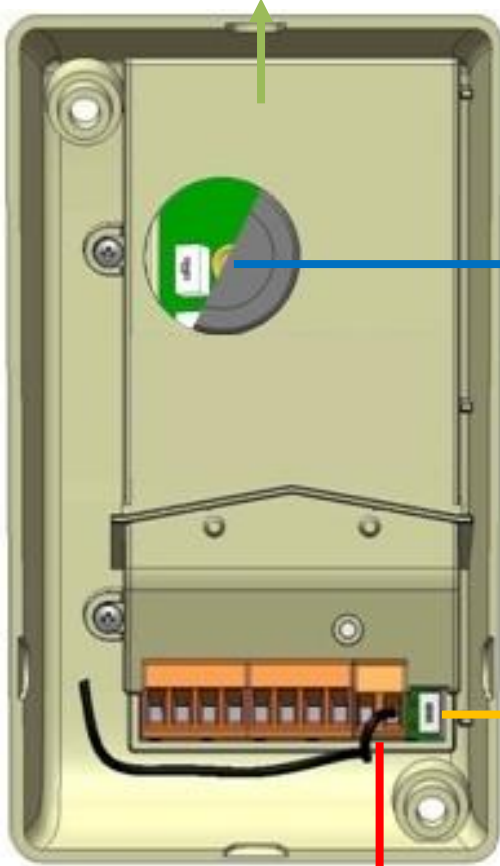



GPRS / GSM



ON
1





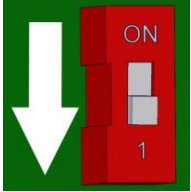

ON
1



IMPULSION / IMPULSE / PULS



ON
1

0.2 s

Seconde / second / sekunde / seconde
/segundo

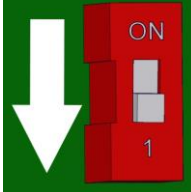

ON
1

5 s Secondes/seconds/sekunden/ seconden
/segundos

Si plage d'accès libre sur intratone.info,
basculez sur 1.

If free access range on intratone.info, switch
to 1.

Wenn der Bereich für den freien Zugriff auf
intratone.info frei ist, wechseln Sie zu 1.

Als het vrije toegangsbereik op intratone.info
is ingeschakeld, gaat u naar 1.

Si el rango de acceso libre en intratone.info,
cambie a 1.

12-0113

Ant. HF	
1	2



Ant. HF	
1	2



HF868 Mhz



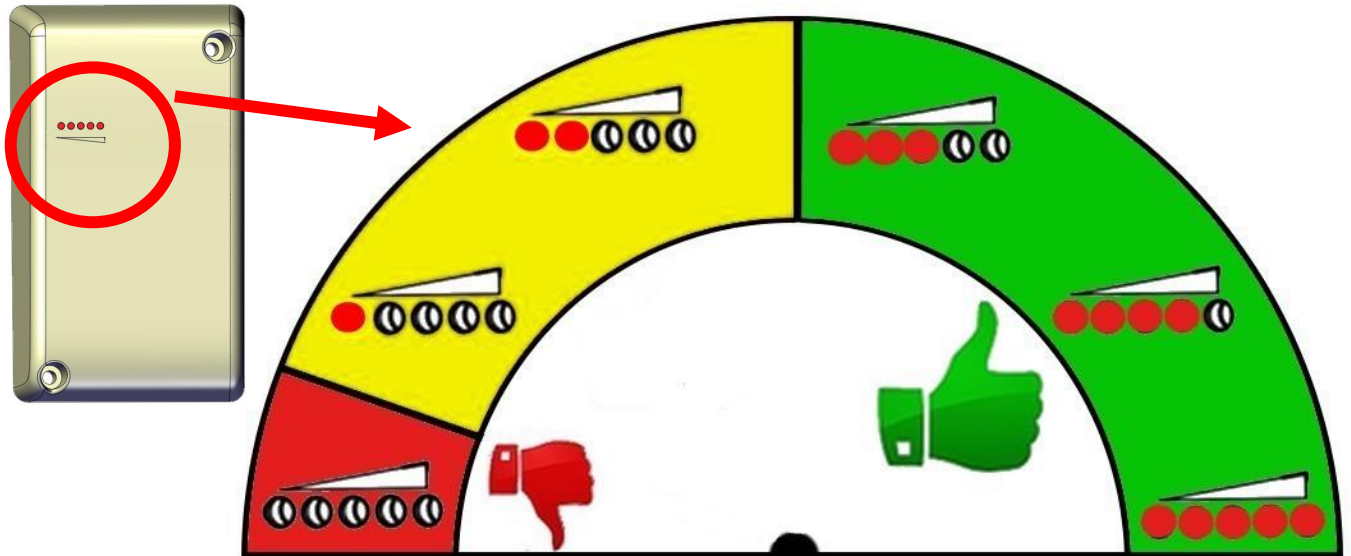

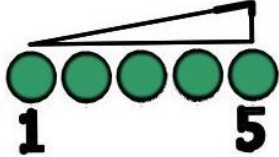
	<p>Démarrage du module Init of the module Block startet Init van de module Init del módulo</p>
--	---

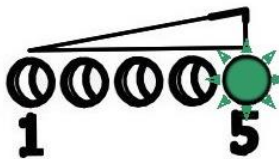
 <p>Clignotement / Blink / blinker / knipperen /parpadear</p>	<p>Recherche de réseau Searching for network Netzwerksuche Zoeken naar netwerk Búsqueda de red</p>
---	---

Ferrite : Protection contre les interférences

Ferrite: Protection against interference

Ferrit: Schutz vor Störungen

Ferriet: bescherming tegen interferentie

Ferrita: protección contra interferencia

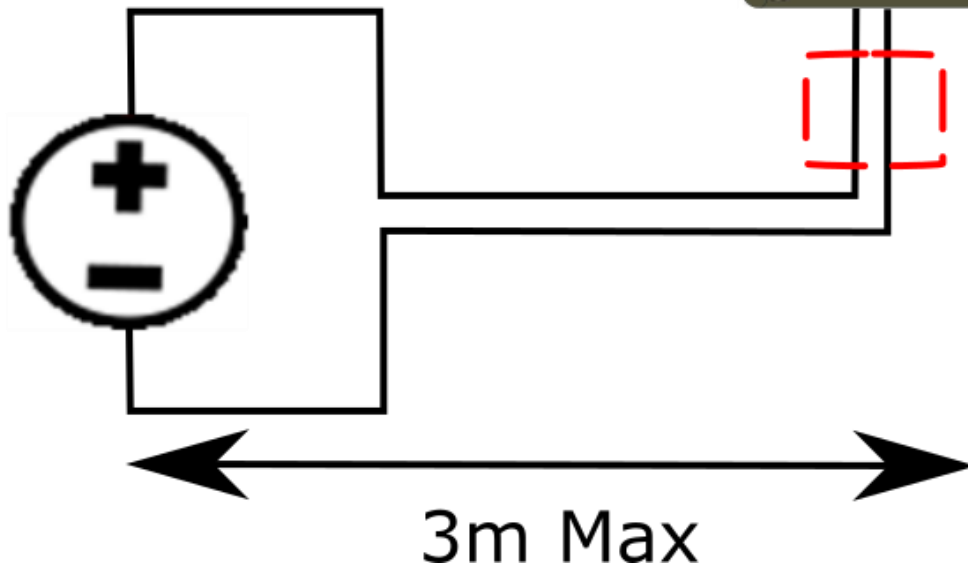

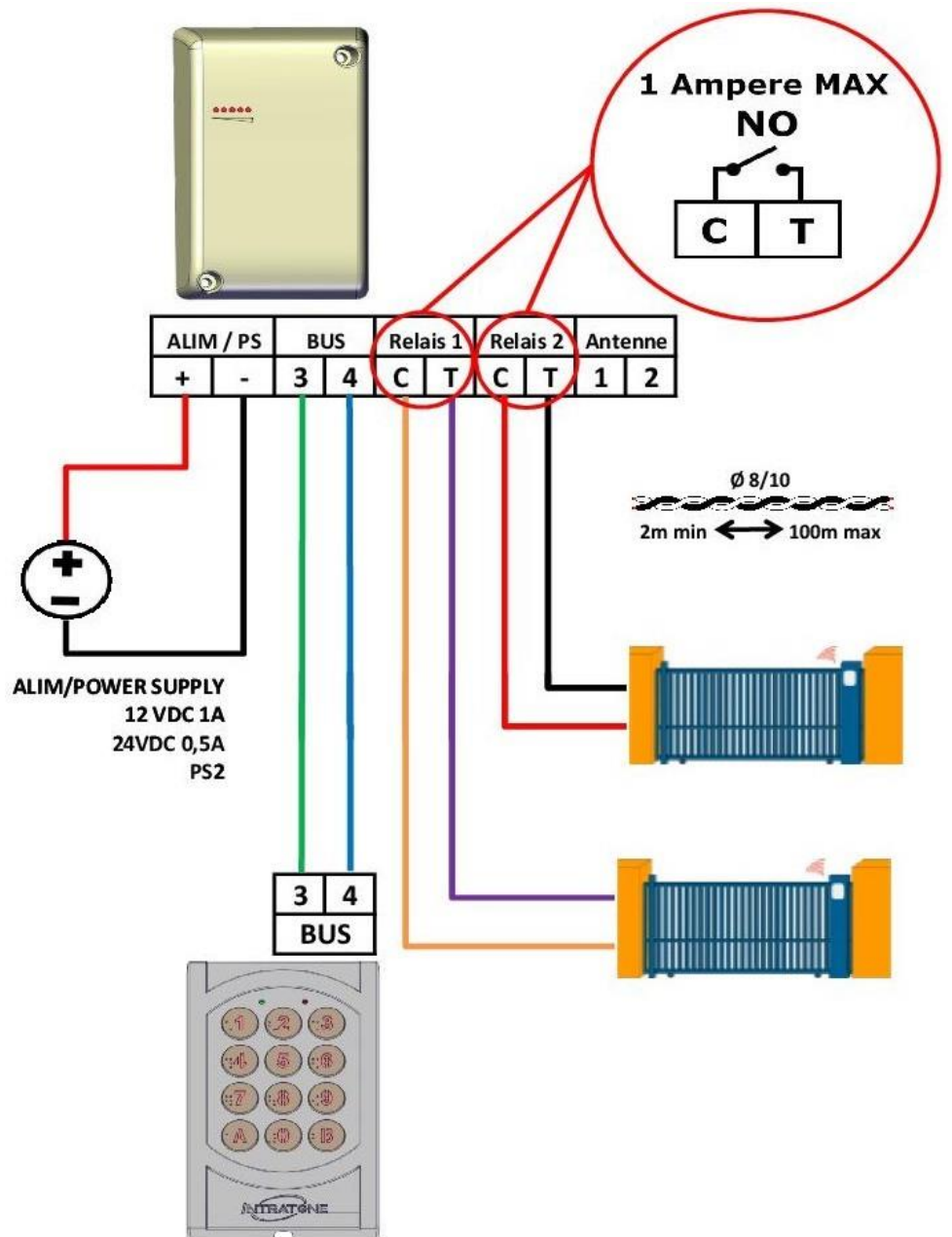

GACHE ou VENTOUSE



Il est nécessaire d'ajouter un relais supplémentaire.

ELECTRIC LOCK or MAGNETIC LOCK

It is necessary to add a relay.

ELEKTRISCHES SCHLOSS oder MAGNETISCHES SCHLOSS

Es ist notwendig, ein Relais hinzuzufügen.

ELEKTRISCH SLOT of MAGNETISCH SLOT

Het is noodzakelijk om een relais van toe te voegen.

BLOQUEO ELECTRICO o BLOQUEO MAGNETICO

Es necesario agregar un relé.

Test avant la 1ère mise à jour
Test before the first update
Testen Sie vor dem ersten Update
Test vóór de eerste update
Prueba antes de la primera actualización

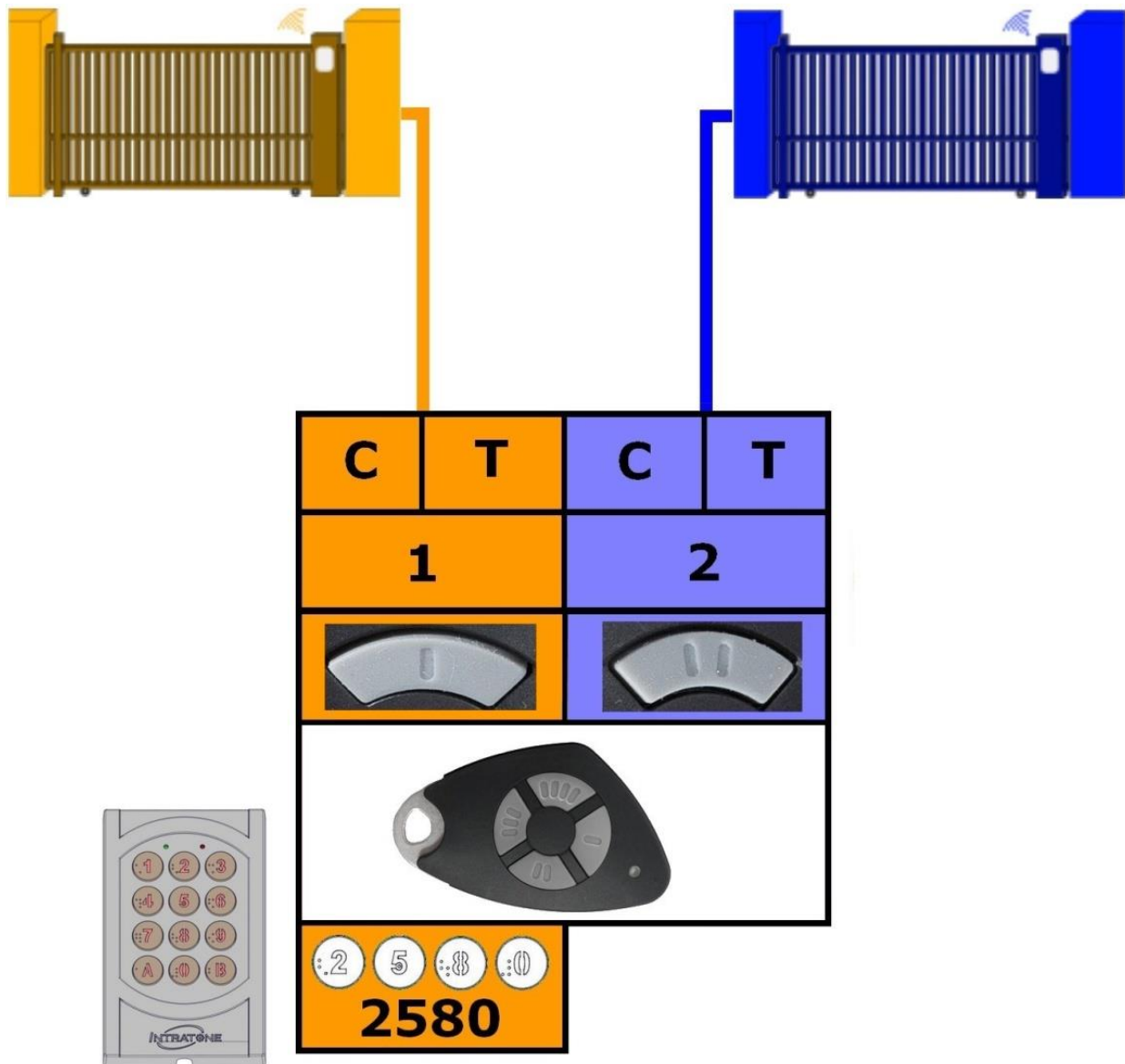

Après la première mise à jour, le mode test prendra fin. Seules les télécommandes autorisées dans www.intratone.info pourront ouvrir.



After the first update, the test mode will end. Only remote controls authorized in www.intratone.info will be able to open.

Nach dem ersten Update wird der Testmodus beendet. Nur in www.intratone.info autorisierte Fernbedienungen können geöffnet werden.

Na de eerste update zal de testmodus eindigen. Alleen afstandsbedieningen die zijn geautoriseerd op www.intratone.info kunnen worden geopend.

Después de la primera actualización, el modo de prueba finalizará. Solo los controles remotos autorizados en www.intratone.info podrán abrirse.



Allez dans la résidence / Go to the residence / Gehe zur Wohnanlagen

1  → 

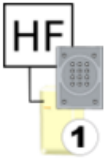

Saisir votre N° de module / Enter your module number / Geben Sie Ihre Modul-/Vertragsnummer ein

2  Numéro de bloc ou numéro de contrat ?





Nommez votre accès / Name your access / Benennen Sie Ihren Zugang



3   ⊗

Pour ajouter des télécommandes / To add remote controls / So fügen Sie Fernbedienungen hinzu

4  → 

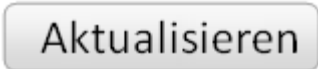
Mettre à jour la résidence / Update the residence / Aktualisieren Sie immer die Wohnanlagen

5    →   

 REF : 04-0107 → 

Ga naar de woning / Ir a la residencia

1

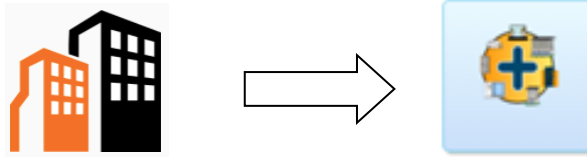

Voer je bloknummer in / Ingrese su número de módulo

2

INTRABOX
DATA

Numéro de bloc ou numéro de contrat ?

XXXXXXXX

Geef uw toegang een naam / Nombra tu acceso

3



Om afstandsbedieningen toe te voegen / Para agregar controles remotos

4

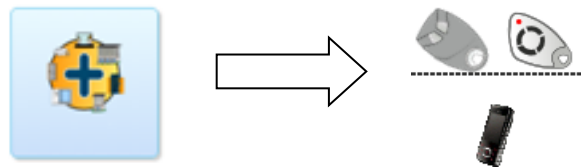

Voordat u vertrekt, moet u de accommodatie altijd bijwerken / Antes de partir, siempre actualice la residencia

5

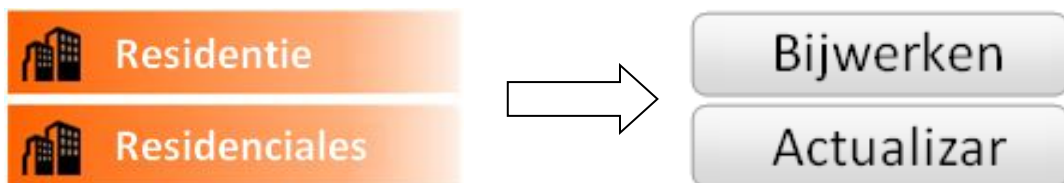

REF : 04-0107

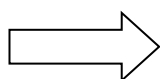

**Garanties de fonctionnement:**

Le module de transmission GPRS MINI HF est garanti dans une plage de température comprise entre -10°C et +45°C et pour une humidité relative maximum de 70%.

Doit être posé selon le sens Haut / Bas préconisé sur l'appareil.

L'installation doit être réalisée par du personnel qualifié possédant les connaissances nécessaires à un montage sûr de l'équipement. Ce kit comprend les éléments nécessaires pour assurer une installation sûre de l'équipement.

L'équipement doit être installé dans une zone dont l'accès est limité (local technique, en hauteur...) au personnel qualifié.

Ne pas installer à l'extérieur en cas de températures extrêmes (Finlande, Suède, Norvège).

**Recyclage du produit en fin de vie:**

Le module de transmission GPRS MINI HF et ses accessoires ne doivent pas être mis au rebut avec les déchets municipaux non triés, mais doivent suivre la filière de collecte et de recyclage des produits DEEE (Déchets d'Equipements Electriques et Electroniques).

**Déclaration de conformité simplifiée**

Le soussigné, COGELEC, déclare que l'équipement radioélectrique du type contrôle d'accès pour l'habitat collectif est conforme à la directive 2014/53/UE (RED). Le texte complet de la déclaration UE de conformité est disponible à l'adresse internet suivante :

www.intratone.fr/documentation

**Warranty operating guarantees:**

The GPRS MINI HF transmission module is guaranteed within a temperature range of -10°C and +45°C and at a relative humidity level not exceeding 70%.

It must be installed according to the Top/Bottom directions given in these instructions and on the device.

The installation must be carried out by qualified personnel with the necessary knowledge for a safe assembly of the equipment.

This kit includes the necessary elements to ensure a safe installation of the equipment.

The equipment must be installed in an area where access is limited (technical room, height ...) to qualified personnel.

Finland, Norway, Sweden : Do not install outside because of extreme temperature

**End-of-life recycling of the product:**

The GPRS MINI HF transmission module and its accessories must not be discarded with unsorted municipal waste, but must be disposed of via the WEEE (Waste Electrical and Electronic Equipment) collection and recycling system.

**Simplified declaration of conformity**

The undersigned, COGELEC, declares that access control type radio equipment for collective housing is in compliance with Directive 2014/53 / EU (RED). The full text of the EU declaration of conformity is available at the following internet

address: www.intratone.fr/documentation

**Funktionsgarantien:**

Der Betrieb des Übertragungsmoduls GPRS MINI HF ist für eine Temperaturspanne zwischen -10 °C und +45 °C und für eine relative Luftfeuchtigkeit von 70 % gewährleistet.

Muss wie auf dem Gegensprechanlage angegeben in der Richtung Oben/Unten eingebaut werden.

Die Installation muss von qualifiziertem Personal mit den notwendigen Kenntnissen für eine sichere Montage der Ausrüstung durchgeführt werden. Dieses Kit enthält die notwendigen Elemente, um eine sichere Installation des Geräts zu gewährleisten.

Das Gerät muss in einem Bereich installiert werden, in dem der Zugang für Fachpersonal begrenzt ist (technischer Raum, Höhe ...). Nicht im Freien bei extremen Temperaturen installieren (Finnland, Schweden, Norwegen).

**Entsorgung des ausgedienten Geräts:**

Das Übertragungsmoduls GPRS MINI HF und sein Zubehör dürfen nicht mit unsortiertem Hausmüll entsorgt werden, sondern müssen an Sammel- und Recyclestellen für Elektro- und Elektronikgeräte-Abfall abgegeben werden.

**Vereinfachte Konformitätserklärung**

Der Unterzeichnete, COGELEC, erklärt, dass funkgesteuerte Zugangskontrollgeräte für den kollektiven Wohnungsbau der Richtlinie 2014/53 / EU (RED) entsprechen. Der vollständige Text der EU-Konformitätserklärung ist unter folgender Internetadresse verfügbar: www.intratone.fr/documentation

**Werkingsgarantie:**

Het GPRS MINI HF -communicatieblok werkt bij temperaturen tussen -10 °C et +45 °C en bij een relatieve vochtigheid van ten hoogste 70%.

Moet gemonteerd worden met de juiste zijden naar boven en onder, zoals aangegeven op het intercom.

De installatie moet worden uitgevoerd door gekwalificeerd personeel met de nodige kennis voor een veilige montage van de apparatuur. Deze set bevat de nodige elementen om een veilige installatie van de apparatuur te garanderen.

De apparatuur moet worden geïnstalleerd in een gebied waar de toegang beperkt is (technische ruimte, hoogte ...) tot gekwalificeerd personeel. Niet buitenshuis installeren bij extreme temperaturen (Finland, Zweden, Noorwegen).

**Recycling aan het einde van de levensduur:**

Het GPRS MINI HF -communicatieblok en zijn toebehoren mogen niet als restafval worden afgevoerd, maar moeten ingeleverd worden bij inzamelpunten voor elektrische of elektronische apparatuur.

**Vereenvoudigde verklaring van overeenstemming**

Ondergetekende, COGELEC, verklaart dat radioapparatuur voor toegangscontrole voor collectieve huisvesting voldoet aan Richtlijn 2014/53 / EU (RED). De volledige tekst van de EU-conformiteitsverklaring is beschikbaar op het volgende internetadres:

www.intratone.fr/documentation

**Garantías de funcionamiento:**

El módulo de comunicaciones GPRS MINI HF está garantizado en una franja de temperatura entre los -10 °C y los +45 °C y con una humedad relativa máxima del 70 %.

Debe colocarse con el sentido Arriba / Abajo que se indica en el interfono.

La instalación debe ser llevada a cabo por personal calificado con los conocimientos necesarios para un montaje seguro del equipo. Este kit incluye los elementos necesarios para garantizar una instalación segura del equipo.

El equipo debe instalarse en un área donde el acceso sea limitado (sala técnica, altura ...) a personal calificado. No lo instales al aire libre en temperaturas extremas (Finlandia, Suecia, Noruega).

**Reciclaje del producto una vez concluida su vida útil:**

No deseche el módulo de comunicaciones GPRS MINI HF, ni los accesorios que incluye, junto con los residuos municipales orgánicos. Debe seguir el procedimiento de recogida y reciclaje dispuesto para los productos RAEE (Residuos de dispositivos Eléctricos y Electrónicos).

**Declaración simplificada de conformidad**

El abajo firmante, COGELEC, declara que los equipos de radio de control de acceso para viviendas colectivas cumplen con la Directiva 2014/53 / UE (RED). El texto completo de la declaración de conformidad de la UE está disponible en siguiente dirección

de internet: www.intratone.fr/documentation

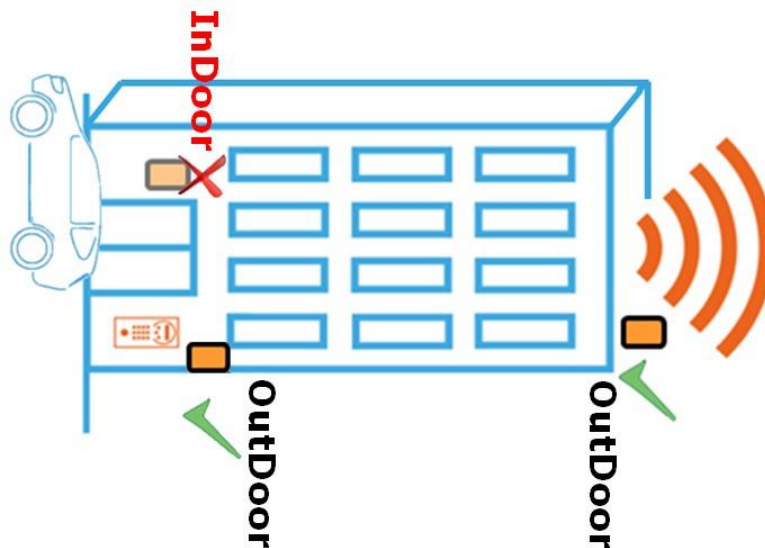

Spécifications techniques / Technical specifications :			
Tensions d'alimentation / Operating voltage	12 – 24Vdc/Vac max.		
Caractéristiques radio GPRS / GPRS Radio frequency characteristics	avec antenne interne / internal antenna :	with	avec antenne externe / external antenna :
GSM900 (880 – 915MHz)	977mW		1122mW
DCS1800 (1710 – 1785MHz)	468mW		105mW
Caractéristiques radio UHF / UHF Radio frequency characteristics			
868.7 – 869.2MHz	Receiver category : 1.5		
Gamme de températures en stockage / Storage Temperatures range	-10 to +45°C		
Gamme de températures en fonctionnement / Operating Temperatures range	-10 to +45°C		
Dimensions	0.096*0.162*0.053		